



MP STRO Membrane Module User Manual

Operation & Maintenance Manual for Spacer Tube Membrane Modules
Applicable model: MP-STRO/MP-STNF



Contents

1. Nomenclature and Type of Membrane Module	3
1.1 Module nomenclature.....	3
1.2 Classification of module pressure level code.....	3
1.3 Module type code.....	3
1.4 Classification of membrane performance characteristics code.....	3
1.5 Active membrane area.....	4
1.6 Classification of raw materials code of metal component.....	4
1.7 Example of nomenclature.....	4
2. Size and Structure of Membrane Module	5
2.1 Module size specification.....	5
2.2 Flow path inside the membrane module.....	6
2.3 MP-ST module exploded view.....	7
2.4 MP-ST module sectioned view	8
3. Operating Instructions for Membrane Modules	9
3.1 Allowable operating condition	9
3.2 Precautions for use	9
4. Assembly of Membrane Modules.....	10
5. Disassembly of Membrane Modules	17
6. Maintenance of Membrane Modules	18
6.1 MPST Module Care	18
6.2 MPST Module Torque Inspection.....	18
6.3 Chemical Cleaning.....	18
6.4 Cleaning Agents	19
6.5 Health and Environmental Hazard:	19
6.6 Cleaning operation regulations and protection measures:.....	19
6.7 First Aid for Accidents.....	20
6.8 Cleaning procedure	20
6.9 MPST Module Storage.....	20
6.10 Preservative solutions.....	21
6.11 Individual MPST modules storage.....	21
7. Quality Warranty and After-Sales Service	21

1. Nomenclature and Type of Membrane Module

1.1 Module nomenclature

The model number of the spacer tube (ST) membrane module consists of five parts: module pressure level, module type, membrane performance characteristics, membrane area, and raw materials of the metal component. Each part is connected with a hyphen "-".

Decoding of the product code:

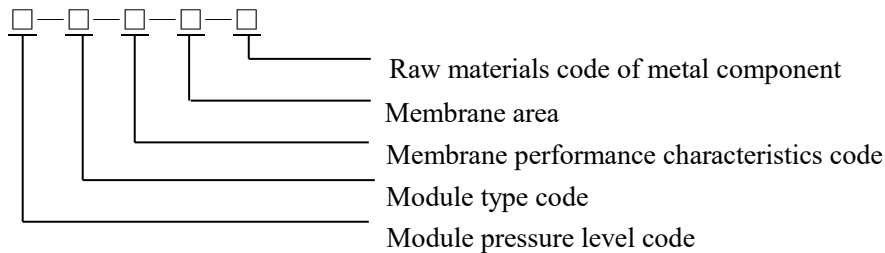

1.2 Classification of module pressure level code

The pressure levels of membrane modules can be divided into normal-pressure spacer tube membrane modules, mid-pressure spacer tube membrane modules, and high-pressure spacer tube membrane modules. The code is indicated by the initials letter, which is shown in Table 1.

Table 1. Module pressure level code

Spacer Tube Modules	Category Code
Normal-pressure modules (operating pressure ≤ 75 bar)	NP
Mid-pressure modules (operating pressure ≤ 90 bar)	MP
High-pressure modules (operating pressure ≤ 160 bar)	HP

* The default pressure level is 90 bar when the component pressure level code is not represented.

1.3 Module type code

The structural form of the membrane module is the spacer tube (ST) membrane module. The category code is indicated by the initial abbreviated letters of the module, which is shown in Table 2.

Table 2. Module type code

Modules Type	Category Code
Spacer tube membrane module	ST

1.4 Classification of membrane performance characteristics code

Table 3. Module type code

Membrane Performance Characteristics	Category Code
High-rejection nanofiltration membranes	NF1
High-flux nanofiltration membranes	NF2
High-selectivity nanofiltration membranes	NF3
Mid-rejection and high-flux reverse osmosis membranes	RO3
High-rejection and high-flux reverse osmosis membranes	RO4
High-rejection and high-temperature reverse osmosis membrane	RO6

* The default membrane performance characteristics are high rejection and high flux reverse osmosis membranes (RO4) when the module type code is not represented.

1.5 Active membrane area

The effective membrane area of a module is expressed in Arabic numbers with the unit of m². The default membrane area is 30 m² when the membrane area is not represented.

1.6 Classification of raw materials code of metal component

Table 4. Raw materials code of metal component for raw influent liquid passing flow

Raw material of metal parts	Category Code
SS316L stainless steel	SS316L
SS2205 dual-phase stainless steel	SS2205
SS2507 super duplex stainless steel	SS2507

* The default raw material of metal parts is SS316 when the raw materials code of metal component is not represented.

1.7 Example of nomenclature

Product code: NP-ST-RO3-30-SS316L

The above product code denotes a normal-pressure spacer tube module with high-flux and high-temperature reverse osmosis membrane; membrane model RO3. The active membrane area is 30m², and the metal component for raw influent liquid passing flow is made of SS316L.

2. Size and Structure of Membrane Module

2.1 Module size specification

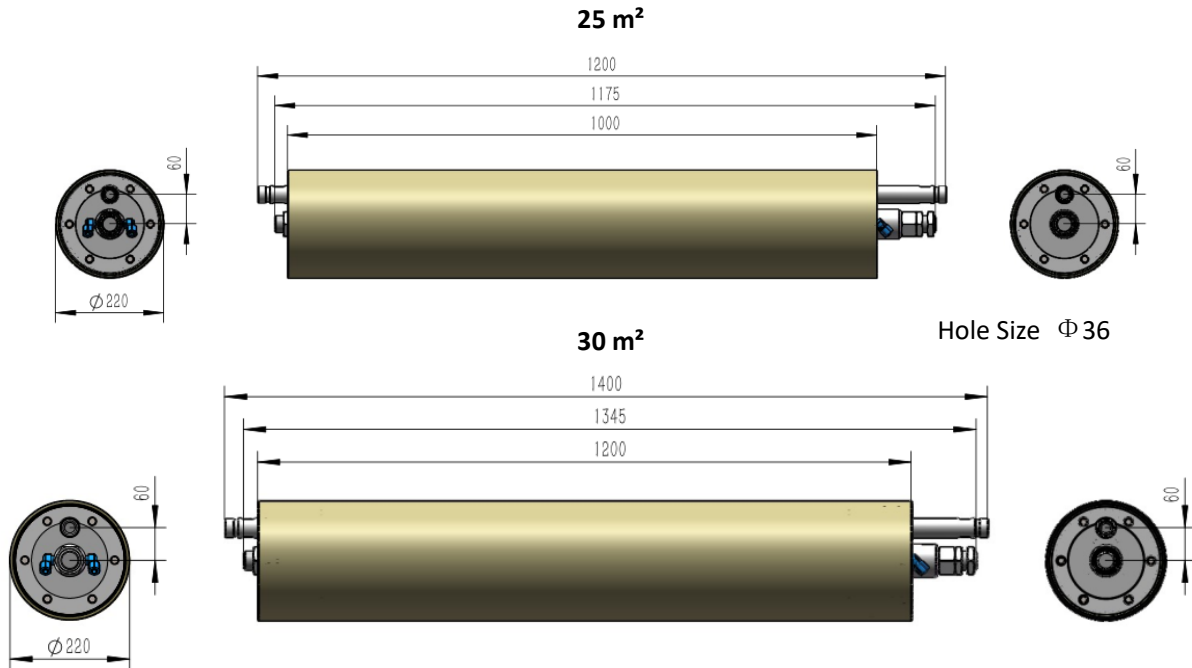

Operating Pressure: $\leq 90\text{bar}$

25m² Weight Dry: 53Kg

30m² Weight Dry: 65Kg

Inlet and Outlet Connection: 1" Victaulic

Permeate Connection: 9mm hose

Hole Size $\Phi 36$

Important note:

- The feed flow direction can come from either end of the ST membrane module. The membrane element **must** be installed to accommodate the flow direction.
- If the feed flows from the top to the bottom of the membrane module, the membrane element seal must be located at the **bottom** of the membrane element.
- If the feed flows from the bottom to the top of the membrane module, the membrane element seal must be located at the **top** of the membrane element.

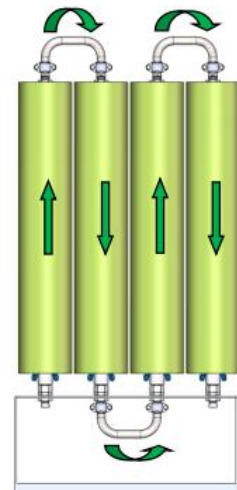

2.2 Flow path inside the membrane module

The drawing on the right has been modified from the full size to enable the details to be seen more clearly.

Green: Feed Water

Blue: Permeate

Red: Seals and O-rings

- As shown in the figure, on this module, the feed flow is from the top. If the feed is from the bottom, the membrane module needs to be reversed to have the element seal at the top.
- The feed water is diffused by the top seal plate to send the feed water evenly around the top of the module.
- The feed water flows down and permeates through the membrane.
- Permeated water (pure water) flows out through the center collecting device into the space around the tie rod and flows down to the permeate outlets.
- The concentrated feed water is channeled by the bottom seal plate to the bottom high pressure connection, and flows out of the module.

Membrane module seals prevent feed water leaking into the concentrate:

Two lip seals and secondary O-ring seals are fitted to the top and bottom sealing flanges to prevent any leakage before operating pressure is reached.

O-rings are fitted to the high pressure connections to prevent leakage.

O-rings fitted to the tie rod to prevent leakage.

O-rings fitted to the end of the membrane element prevent contamination of permeate by the feed water.

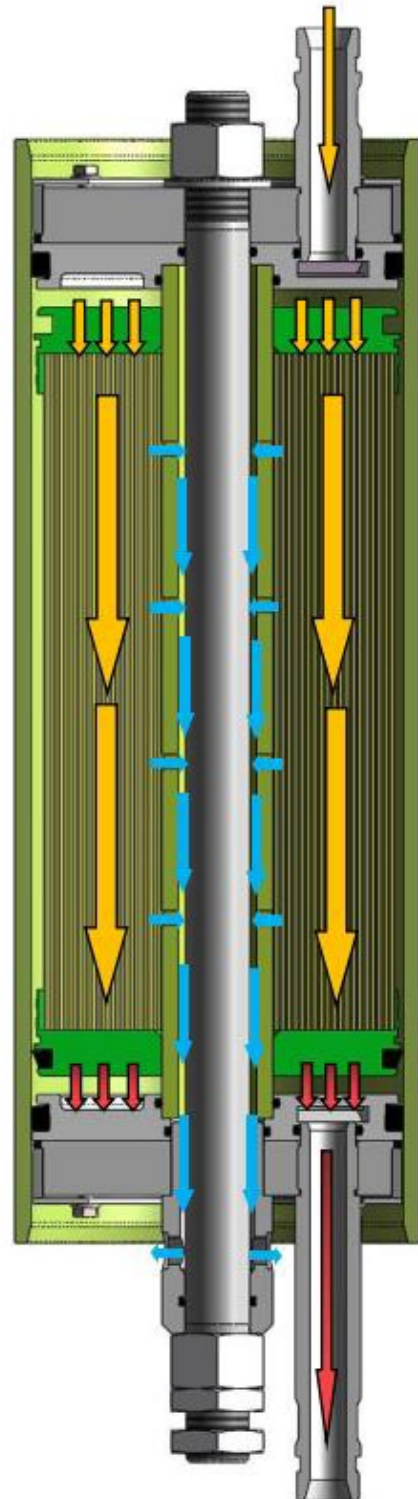

2.3 MP-ST module exploded view

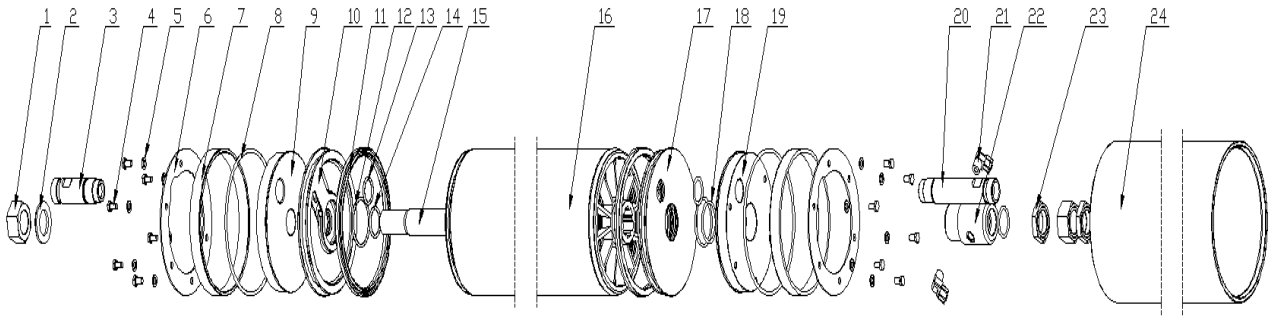

No.	Material Number	Name	Material	Quality
1	72011001	Full Nut	35CrMo	2
2	72011011	Washer	2205	1
3	81114004	High Pressure Connection (short)	2205	1
4	72210001	Outer Hexagonal Bolts	SS304	12
5	72299001	Flat Washer	SS304	12
6	72010014	Prestress Disc	2205	2
7	71122003	Isolating Ring	POM	2
8	71210017	O-ring	NBR	2
9	72010012	Top Flange	SS316L	1
10	71122001	Top Seal Flange	POM	1
11	71211001	Lip Seal	EPDM	2
12	71210016	O-ring	NBR	2
13	71210015	O-ring	NBR	2
14	71210006	O-ring	NBR	2
15	81113005 / 81113008	Tie Rod	14Cr17Ni2	1
16	Membrane Element		1
17	71122002	Bottom Seal Flange	POM	1
18	71210018	O-ring	NBR	1
19	72010013	Bottom Flange	SS316L	1
20	81114002	High Pressure Connection	2205	1
21	71160001	Male Elbow (Permeate Outlet)	POM	2
22	81111004	Permeate Collector	2205	1
23	72011002	Lock Nut	35CrMo	2
24	71510002 / 71510003	Membrane Vessel	FRP	1

2.4 MP-ST module sectioned view

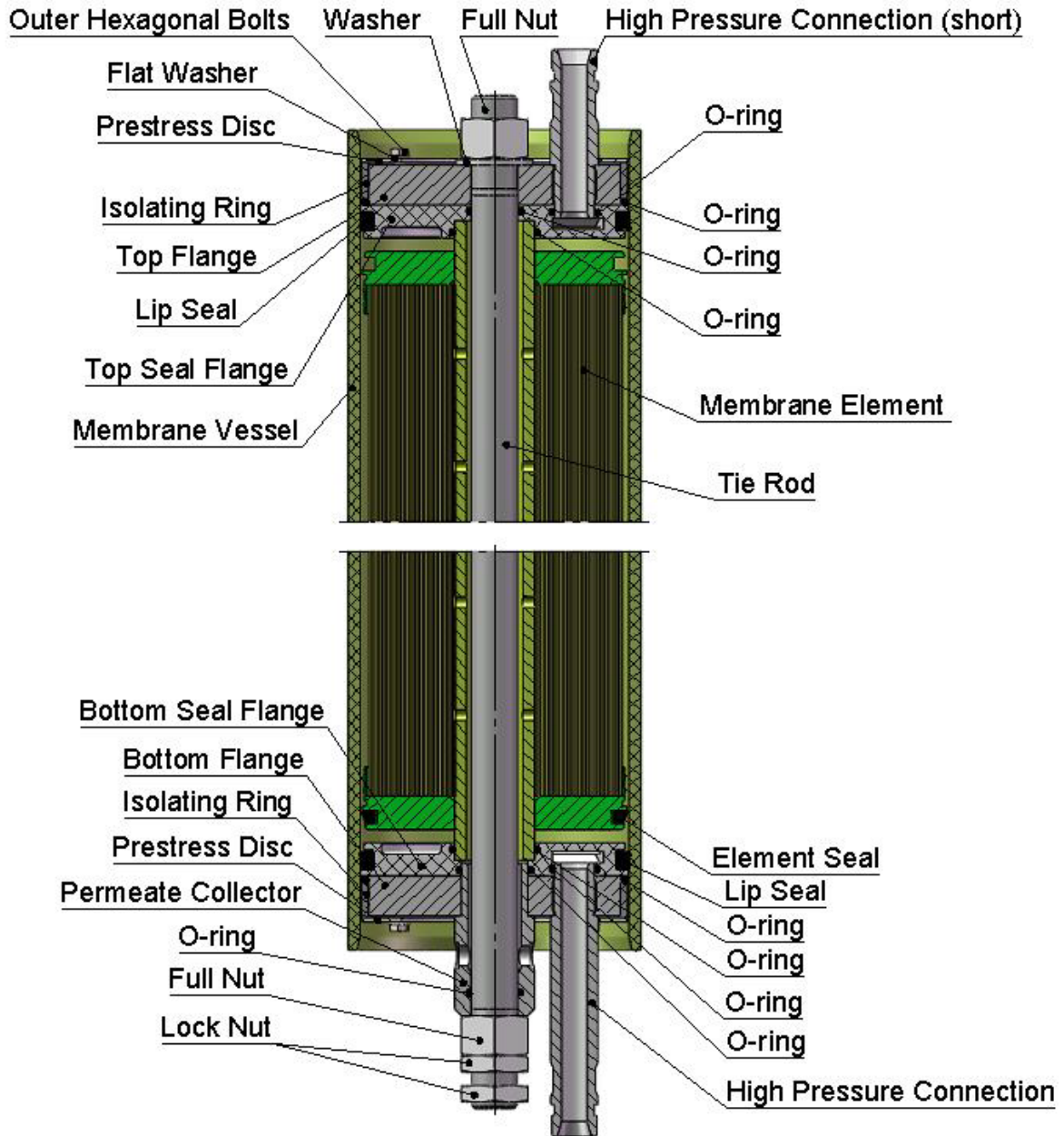

On this module, the feed flow is from the top. If the feed is from the bottom, the membrane module needs to be reversed to have the element seal at the top.

3. Operating Instructions for Membrane Modules



Caution

Do not disassemble the membrane module while it is operating under high pressure. The membrane module must be disassembled and serviced only after all system equipment has been shut down and there is no pressure in the tube connected to the membrane module.

3.1 Allowable operating condition

- Feed Flow: 3-10 m³/h depending on water quality
- pH range: 3-10 (2-12 during cleaning)
- Temperature range: 5-45 °C
- Operating pressure: ≤**90 bar**

3.2 Precautions for use

1) Arrival

Please check the outer package carefully for any damage when you receive the membrane module. In case of apparent damage, kindly inform us immediately.

2) Storage

Please store the membrane modules in a cool environment of 5-30°C, with humidity not exceeding 70%. Avoid direct UV/sunlight. New membranes in the original packaging can be stored for six months.

3) Installation

Before installing the membrane module, the equipment should be rinsed with water. Ensure that there is no hard solid particle inside of equipment and in feed water. Hard solid particles may cause damage to the membrane module. Clean water, glycerin and membrane cleaner solution can be used as a lubricant when installing membrane modules.

4) Initial flush

Prior to the first operation, the membrane module needs to be rinsed with clean water for at least 30 minutes.

5) Operation

According to the raw water quality, a suitable **pretreatment** process needs to be adopted to avoid the physical clogging of the membrane modules.

During regular use, it is important to prevent sudden opening or closing of the valve, which can cause water hammer and thus damage the membrane.

The membrane should be kept at the recommended operating conditions. Do not exceed the maximum operating range of pH, temperature, pressure and differential pressure range of the membrane module.

Backwashing of spacer tube membrane modules is prohibited, and the produced water side should not hold pressure.

6) Cleaning

When a significant decrease in membrane flux is detected, a chemical cleaning procedure can be taken to recover the membrane module performance. UNISOL recommends using professional membrane cleaners.

7) Shutdown and storage



If the system needs to be shut down for more than 3 hours, the membrane module should be flushed and filled with water.

If the system is shut down for more than 24 hours, the system should be flushed and preserved with sodium bisulfite solution. The preservation solution should be changed weekly.

Note: Deionized water and softened water are preferred for membrane module rinsing and cleaning. Tap water with high hardness and alkalinity may produce new contamination to the membrane modules during the cleaning process.

4. Assembly of Membrane Modules

This procedure will only be carried out when the membrane module needs to be replaced. Before a membrane module assembly, please read this instruction carefully and follow the procedures below.

	Do not disassemble the membrane module while it is operating under high pressure. The membrane module must be disassembled and serviced only after all system equipment has been shut down and there is no pressure in the tube connected to the membrane module.
	The torque moment load must be maintained at 30 NW. Torque tightening must be done after the chemical cleaning, at which point the assembly should be shut down.
	Cleaning of the module must be done according to the stated protocol. Improper cleaning processes will affect the performance of the module and reduce the service life of the membrane.

Note: All O-rings and seals should be replaced with new parts at each assembly

Tools required for installation:

- 32 mm open-end spanner
- 50 mm open-end spanner
- 17 mm open-end spanner(for removing Victaulic pipe clamps)
- 10-150Nm torque wrench
- Molykote® Greases (lubricant and sealant)
- Glycerin

Parts to be replaced to install a MP-ST module:

NO.	Material Number	Name	Material	Quantity
8	71210017	O-ring	NBR	2
11	71211001	Lip Seal	EPDM	2
12	71210016	O-ring	NBR	2
13	71210015	O-ring	NBR	2
14	71210006	O-ring	NBR	2
16	ST Membrane Element		1
18	71210018	O-ring	NBR	1
	71211004	Seals	EPDM	

- Step 1: Fit the O-rings (material# 71210006, 71210015, 71210016) on the top seal flanges. Fit the O-rings (material # 71210015, 71210016, 210018) on the bottom seal flanges.



Top Seal Flange



Bottom Seal Flange

* Please note the difference between the top seal flange and the bottom seal flange. The lower seal flange has a large O-ring (material # 71210018).

- Step 2: Fit the lip seal (material # 71211002) onto the top seal flange and the bottom seal flange.



* Note the correct direction of the lip seal. The lip opening must face toward the membrane module

- Step 3: Use PTFE tape to wrap around the threads of the high pressure connection tube 4-6 turns, then screw the high pressure connection tube into the top flange and tighten it with a 32 mm spanner.



- Step 4: Fit the O-rings (material #71210017) to the top flange.
- Step 5: Fit the isolating ring.
- Step 6: Fit the prestress disc onto the top flange with six outer hex bolts and flat washer. Screw the hex bolts to halfway.



Step4



Step5



Step6

- Step 7: Fit the pre-prepared top seal flange with O-rings and lip seal to the prestress disc, then complete the top end.
- Step 8: Same procedure for the bottom flange. Use PTFE tape to wrap around the threads of the high pressure connection tube 4-6 turns, then screw the high pressure connection tube into the bottom flange and tighten it with a 32 mm spanner.
- Step 9: Fit the O-rings (material #71210017) to the bottom flange.
- Step 10: Fit the isolating ring to the bottom flange.
- Step 11: Fit the prestress disc onto the bottom flange with six outer hex bolts and flat washer. Screw the hex bolts to the halfway.



Step 8



Step 9



Step 10



Step 11

- Step 12: Fit the pre-prepared top seal flange with O-rings and lip seal to the prestress disc.
- Step 13: Screw the permeate elbow tightly into permeate collector with PTFE tape.
- Step 14: Fit the O-ring (Material # 71210006) onto permeate collector.



Step 12



Step 13



Step 14

- Step 15: FIT the prepared permeate collector by aligning with the high pressure connection and push into the bottom flange.
- Step 16: Complete the bottom end.



Step 15



Step 16

- Step 17: Apply a suitable grease to the threaded section at both ends of the tie rod. Molykote grease is highly recommended.
- Step 18: Simply lay the tie rod flat on an operating table. Apply glycerin to one end, and install the prepared bottom flange into the glycerin-coated end until all threads are exposed.
- Step 19: Tighten the full nut to the end of the threads and tighten the bottom flange assembly against the full nut. Then tighten the lock nut to the full nut.

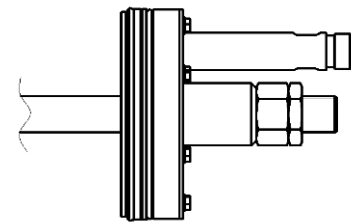
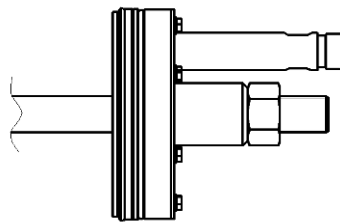
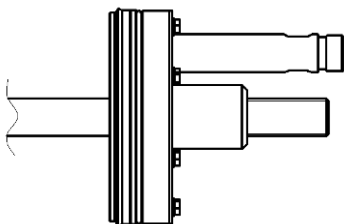

- Step 20: Attach the bottom flange assembly to the support frame. The block shown here in red is welded to the frame to prevent the lock nut and tie rod from rotating. Use the lock nut to lock the tie rod in the vertical position.

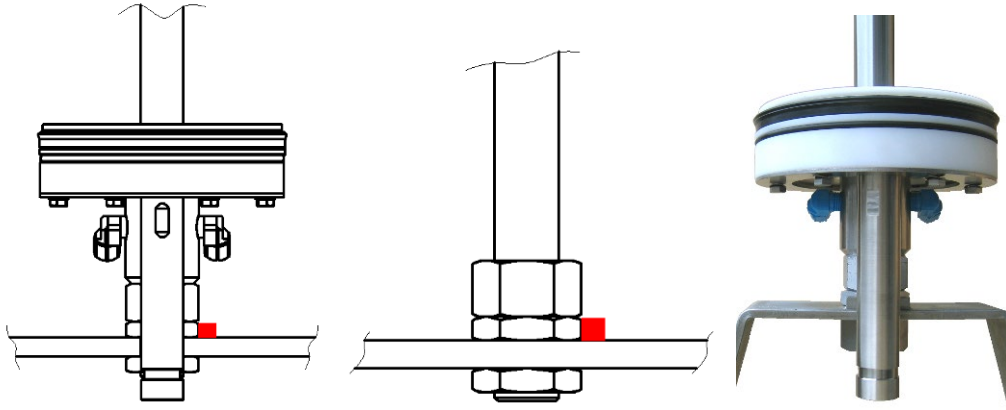

- Step 21: Remove the MP-ST membrane element from the package. Inspect the exterior and center tube to ensure that the membrane element is free of any dust or other debris. If needed, use a compressed air gun to blow through the center tube. **Only clean dry air can be used.**

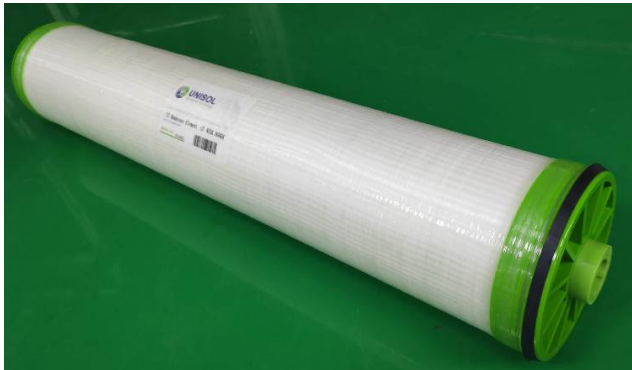

- Step 22: Before installing the MP-ST membrane element, it is important to confirm the inlet flow direction of the membrane module. The membrane element seal **must** be located at the correct end of the membrane element. The arrow shows the correct inlet flow direction for the seal location.



- Step 23: Install the membrane element over the tie rod and onto the bottom flange assembly.



- Step 24: Apply glycerin to the end of the tie rod.



- Step 25: Install the pre-prepared top flange assembly to the tie rod and membrane element.



- Step 26: Check that the piping connections to this membrane assembly are aligned with the sketch here. The inlet and outlet connections should be vertically aligned. If not, position the top component to fit into the interconnect pipeline.

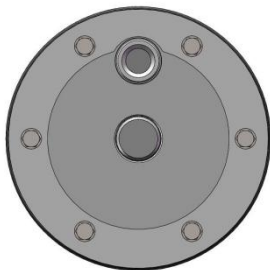

Top Connection

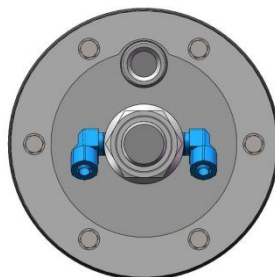

Bottom Connection

- Step 27: Fit the full nut and flat gasket to the tie rod and torque the nut to 30 Nm.
- Step 28: Slide the membrane vessel into the ST membrane assembly and check that the vessel is against the black limit block.
- Step 29: Tighten the six outer hex bolts on the top and bottom flange.



Step 27



Step 28



Step 29

- Step 30: Install the membrane module to the device.
- Step 31: Connect high pressure pipe, connectors, and produced water hoses as required.

5. Disassembly of Membrane Modules

- 1) Pull out the membrane vessel.
- 2) Inspect the membrane vessel for any damage or scratches.
- 3) Remove the top flange assembly, all O-rings, and lip seals.
- 4) Inspect the top flange assembly for any corrosion and clogging.
- 5) Remove the ST membrane element.
- 6) Remove the bottom flange assembly, all O-rings, and lip seals.
- 7) Inspect the bottom flange assembly for any corrosion and clogging.
- 8) Clean the tie rod.

Importance

UNISOL's MP-ST membrane modules are designed with a feed water temperature of **25°C** as the standard. **25°C** is the optimum feed temperature. Feed water temperature must always be taken into account when checking the permeate flux. If the permeate flux is 10% to 15% less than the theoretical calculation, a chemical cleaning will be required.

6. Maintenance of Membrane Modules

Any leakage must be dealt with immediately

6.1 MPST Module Care

Each time before stopping, the MPST membrane module should be flushed with permeate water to prevent salt precipitating from concentrated feed water and onto the membrane cushions when the unit is stopped.

If the unit is to be taken out of service for more than 4 days, the MPST membrane module should be flushed with a membrane biocide prior to shutdown in order to prevent bacterial growth in the ST membrane module. All seawater contains bacteria. The dark and warm interior of the ST module is the ideal place for bacterial growth. Normally this can be removed with membrane cleaning agents, however, there is no guarantee that the bacteria will be completely removed.

6.2 MPST Module Torque Inspection





An inspection of the torque loading on the top full nut is required every 6 months.

The inspection should comply with the following sequence of steps. **The unit must be stopped and pressure-free at each time of inspection.**

- 1) Remove the Top Half Nut, and loosen the top nut by 1/2 turn with a 50mm spanner and a torque wrench.
- 2) Torque load the top nut to 30 Nm, then replace the top half nut back.

$$30 \text{ Nm} = 3 \text{ Kgm} = 20 \text{ lbf ft} = 525 \text{ lbf ins}$$

6.3 Chemical Cleaning

	<p>DO NOT USE MULTIPLE MEMBRANE CLEANERS AT THE SAME TIME</p> <p>Mixing membrane cleaning solutions will neutralize and reduce the cleaning effectiveness and also damage the membrane surface.</p>
	<p>DO NOT USE CLEANING AGENTS CONTAINING OXIDIZING AGENTS, WHICH CAN CAUSE PERMANENT DAMAGE TO THE MEMBRANE.</p> <p>(e.g. free chlorine, chlorine gas, ozone, etc.)</p>
	<p>DO NOT USE HANDS OR OTHER SOFT TOOLS TO CLEAN THE MEMBRANE.</p> <p>This will affect the rejection performance and loss its desalination capability.</p>
	<p>DEIONIZED WATER IS RECOMMENDED FOR CLEANING AND PRESERVATION PURPOSES.</p>

6.4 Cleaning Agents

	Enzyme Detergents	Alkaline Detergents	Acidity Detergents
Formulation	0.25-1.0%W/W JIARONG EP Cleaning Solution	0.25-1.0%W/W JIARONG CP120 Cleaning Solution	0.25-1.0%W/W JIARONG AP310 Cleaning Solution
Cleaning Condition	Circulation for 60-90 minutes at pH 8.0-8.5 and a temperature of 30-40°C.	Circulation for 60-90 minutes at pH 10.0-11.0 and a temperature of 30-40°C.	Circulation for 60-90 minutes at pH 3.0-4.0 and a temperature of 30-40°C.
Cleaning Purpose	Removal of membrane surface contamination targeting organic matter, mud, saccharides, and mucilage	Removal of membrane surface contamination targeting organic matter, mud, saccharides, and mucilage	Removal of membrane surface contamination targeting inorganic salts and metal precipitation
Criteria for deciding if cleaning is necessary	<ol style="list-style-type: none"> 1. Flux decreases to 10-15% of the initial flux (or after the last chemical cleaning). 2. Inlet and outlet membrane pressure drop increase to 10-15% of the initial pressure drop (or after the last chemical cleaning). 3. Rejection decreases to 10-15% of the initial rejection (or after the last chemical cleaning). 		

6.5 Health and Environmental Hazard:

- Inhalation or swallowing of chemical cleaning agents can cause damage to the body, resulting in burns and bronchitis.
- Direct contact with chemical cleaning chemicals may cause temporary physical discomfort such as coughing, labored breathing, and eye burns.
- Hazardous to water - avoid entering surface water and sewage.

6.6 Cleaning operation regulations and protection measures:

- Strictly in accordance with the cleaning agent manufacturer's instructions for the use of cleaning chemicals.
- Good ventilation should be ensured during operation, and the container should be sealed immediately after use.
- Avoid contact with eyes, skin, and clothing. Hands must be thoroughly washed after finishing work and before each work.
- Wear alkali-resistant protective clothing or a plastic apron when diluting or refilling. Change clothes immediately after finishing work and keep casual clothes separate from work clothes.
- **Goggles and masks** must be worn to prevent splash hazards.
- **Gloves** must be made of natural rubber, neoprene, nitrile, butyl rubber, and fluorinated rubber. It is recommended that cotton gloves be worn under protective gloves.



6.7 First Aid for Accidents

- In case of any accidents, protect yourself first then **notify a doctor immediately**.
- In case of contact with eyes: flush with water or eyewash solution for at least 10 minutes.
- In case of contact with skin: immediately remove contaminated clothing and rinse with plenty of soapy water or pure water for at least 15 minutes.
- In case of respiratory aspiration: keep the airway open, remove dentures and spit out any vomit. If breathing or heartbeat stops, apply cardiopulmonary resuscitation (CPR) and call a local healthcare provider for help **immediately**.
- In case of accidental swallowing: stay conscious, try to drink plenty of water, and seek help from a local healthcare provider **immediately**.



6.8 Cleaning procedure

- Before cleaning, the residual liquid in the system should be jacked out of the system with deionized water.
- Determine if a chemical cleaning is required by measuring the water flux. Convert the system valve to the CIP state (i.e., both concentrate and permeate are circulated back to the CIP tank). Turn on the equipment, set the pressure control at 20 bar. Once the operation has stabilized, record the permeate flux at this point and compare it to the initial membrane flux. If it drops to 85% of the initial, a cleaning should be performed.
- Determine the contaminants according to the produced liquid. Choose the appropriate cleaning formula for different contaminants. Please refer to the cleaning chemicals table above, Prepare cleaning solution to the CIP tank.
- Run the machine based on the standardized procedure of measuring water flux, and clean it according to the following cleaning scheme.

	Method	Solution	Temperature (°C)	Running Time (min)
Step 1	Flush with water	Warm water	35-40	15-30
Step 2	Flush with cleaning agents	Appropriate cleaning agents	30-40	60-90
Step3	Flush with water	Deionized water	Room temperature	15-30

- The pH value should be monitored during the cleaning process. If the pH value increases, the cleaning agent should be added appropriately to maintain the cleaning pH level. Cleaning with AP detergent requires a pH of no lower than 11.5. However, the pH value should not exceed 12 in order to protect the components from damage. The temperature at the end of the cleaning must reach 40 °C.

6.9 MPST Module Storage

Membrane elements are made of organic materials. Bacteria can multiply on the membrane surface, and damage the activation layer of the membrane surface resulting in loss of membrane performance. In case the membrane equipment needs to be shut down for a period of time, the proper preservation solutions can be prepared and stored in the module to prevent the growth of bacteria depending on the downtime.

	CAUTION Membrane components should always be kept moist after being wetted with water. Failure to store the membrane element properly will result in damage to the membrane. The terms of the warranty will automatically be void at that point.
---	--

6.10 Preservative solutions

Storage Period	Preservative Solution
> 3 days	Fully filled the module with deionized water
> 7 days	0.1%W/W Sodium bisulfite solution. Circulation for 30minutes at a temperature of 10-25°C.
> 30 days	0.25%W/W Sodium bisulfite solution. Circulation for 30minutes at a temperature of 10-25°C.
> 12 month	0.25%V/V Carlson solution mix with 18%V/V Glycerin (reagent grade, 98%). Circulation for 60 minutes at a temperature of 10-25°C.

6.11 Individual MPST modules storage

- Dry MPST module should be placed in sealed plastic packaging and stored in a dry place away from direct sunlight at a temperature of 5°C - 30°C.
- Wet MPST module should be stored in a standard protective solution of 1% food-grade sodium bisulfite. Soak the ST module in the standard protective solution for 1 hour, then place the module in a sealed plastic bag and stored it in a dry place away from direct sunlight at a temperature of 5°C - 30°C.

7. Quality Warranty and After-Sales Service

- 1) The quality guarantee period for MPST membrane modules is 12 months under normal operating conditions (except for human error, physical blockage, etc.) from the date of shipment. Under well-maintained conditions, the membrane service life is usually 2-3 years depending on the water quality and cleaning frequency.
- 2) UNISOL offers free technical guidance in case of quality problems in the use of membrane modules. If the problem still cannot be solved, UNISOL will assign relevant professional technicians to the site to provide the appropriate solution.
- 3) During the warranty period, UNISOL offers free parts repair or replacement for damaged elements due to quality reasons